

**Attrezzi per messa in fase alberi a camme**

Tool for camshaft regulation



- 215 001 Bravo-Brava-Delta-Y10 Mot. Eng.1400 cc 12V
- 215 002 Lancia K anno 97 in poi 5 cil. Bravo gamma 98 Marea gamma 99 Alfa 155 Vis 2000 20 v
- 215 003 Lancia 2.4 - Alfa 3.0 V6 24 V
- 215 004 Lancia motore VIS 4 cil - Lancia K 2.4 20V
- 215 005 Lancia K 5 cil anno 96 2000 20 v
- 215 006 Bravo Brava Marea Lancia 115 cv senza variatore di fase 1800 16 v
- 215 008 Coupè Barchetta Lancia 130 Cv con variatore di fase 1800 16 v
- 215 009 Punto HGT - Motore con variatore di fase e collettore a geometria variabile 130 Cv 1800 16 v
- 215 010 Bravo Brava Marea 2000 20v
- 215 011 Alfa motore STEP A 1600 16v
- 215 012 Alfa 1.4/1.6 16v - Alfa 147 1.6 16V
- 215 013 Alfa 1.8/2.0 16V - Alfa 147 2.0 16V
- 215 014 Alfa 147 1.6 16V 105 Cv
- 215 015 Alfa 2.0 JTS
- 215 016 Alfa - Lancia 3.2cc

**Cassetta attrezzi messa in fase albero a camme**

Kit of tools for camshaft regulatio



- 215 021 14 motori - Motor/engine Fiat - Alfa - Lancia  
Composizione: 215 001 - 002 - 003 - 004 - 005 - 006 - 008 - 009 - 010 - 011 - 012 - 013 - 014 - 015

**Cassetta attrezzi messa in fase albero a camme**

Kit of tools for camshaft regulatio



- 215 022 13 Motori - Fiat - Alfa - Lancia  
Composizione: 215 001 - 002 - 004 - 005 - 006 - 008 - 009 - 010 - 011 - 012 - 013 - 014 - 015

**Attrezzo bloccaggio albero motore per messa in fase albero a camme**

Kit of tools for camshaft regulatio



- 215 025 Bravo-Brava-Delta-Y10 - Mot.Eng.1400 cc 12V

**Coppia di attrezzi per bloccaggio in fase albero a camme**

Twin tool holder for camshaft



- 215 026 Nuova Punto - Lancia Y - Mot.Eng.1200 cc 16v

**Coppia di tastatori per bilanciamento pistoni durante la messa in fase albero a camme**

Twin tool for regulation piston stroke



- 215 027 Nuova Punto - Lancia Y - Mot.Eng.1200 cc 16v

**Blocchetto fissaggio puleggia distribuzione durante il serraggio della vite centrale della puleggia**



- 215 02701 Mot.1400 cc 16v EVO2

**Attrezzo blocco albero motore Fiat**

Wrench for Block arbor Fiat motors



- 215 028 FIRE
- 215 029 Punto 188

**Coppia attrezzi messa in fase alberi camme**

Tools for camshaft regulation



- 215 030 Bravo-Brava-Stilo- Multipla 1581 16v

**Kit messa in fase Motori Fiat 1.6 16V**

Kit for camshaft regulation



215 031

**Ricambi - Spare parts**

213 557 Supporto PMS

215 030 Coppia attrezzo fase

215 570 Chiave tendicinghia Fil. mm 8

PER STILO E MULTIPLA BIPOWER VEDERE 215 571 E 215 57101

**Confezione messa in fase alberi a camme, distribuzione e sostegno bicchierini punterie idrauliche**

Tool for camshaft regulation

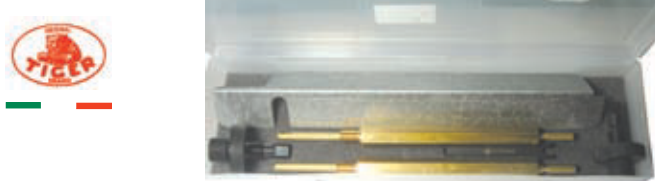

215 033 Nuova Punto - Lancia Y - Mot.Eng.1200 cc 16v

**Ricambi - Spare parts**

213 680 Lamiera supporto bicchierini

215 026 Perni blocco camme

215 027 Tastatori bilancio pistoni

215 610 Chiave tendicinghia

**Kit messa in fase cinghia di distribuzione motori Fiat 1.2 16V e Motori 1.4 16V EVO 2**

Tool for camshaft regulation



codice  
215 034

**Ricambi - Spare-parts**

215 026 Coppia di attrezzi bloccaggio alberi a camme

215 027 Coppia di tastatori per bilanciamento pistoni

215 027 01 Attrezzo blocco puleggia distribuzione 1.4 16V

215 610 Chiave a 2 denti per rotazione tendicinghia della distribuzione

213 680 Coppia di lamierini di sostegno delle punterie idrauliche

**Confezione per messa in fase motore**

Tool for camshaft regulation



215 035 Bravo-Brava-Delta-Y10 - Mot.Eng.1400 cc 12V

**Ricambi - Spare parts**

215 025 Piastra blocco albero motore

215 001 Cavallotto blocco albero a camme

**Attrezzo fase albero distribuzione motori Fiat FIRE**

Wrench for block camshaft Fiat FIRE motors



215 038 Per motori dal n. 6800001 a 7000000

215 038 01 Per motori con n. superiore a 2533528

**Kit messa in fase motori 2.2 Benzina**

Kit for camshaft regulation engine 2.2 gasoline



215 039 Alfa 159 - Fiat Nuova Croma

**Ricambi - Spare-parts**

215 039 01 Staffa blocco alberi a camme

215 039 02 Leva puleggia albero motore

215 039 03 Blocco alberi controrotanti

**Attrezzo blocco pompa acqua per motori Fiat 2.2 Benzina**

Block pulley for water pump - Engine 2.2 gasoline



215 039 04 Alfa 159 - Fiat Nuova Croma

### Kit rimozione pompa acqua VW Tuareg 2.5 D



215 039 10 Motori BAC-BLK-BPD-BPE

### Kit per lavoro su organi distribuzione motore



215 040 Fiat Barchetta-Coupè - Kit completo

#### Ricambi - Spare-parts

215 041 particolare 1 - estraattore

215 042 particolare 2 - rotazione albero

215 043 particolare 3 - smontaggio variatore

215 044 particolare 4 - tenditore

### Kit attrezzi fase SUV DR5

Timing tool set for DR5 SUV

codice  
215 045



#### Ricambi - Spare-parts

215 045 01 Piastra blocco camme

215 045 02 Perno blocco motore

### Kit per messa in fase motori F1A - F1C IVECO Daily & Ducato 2.3 - 2.8 - 3.0cc

Wrench test distribucion IVECO Daily and Ducato F1A-F1C motors



215 046 Kit completo

#### Ricambi - Spare-parts

215 046 01 Asta blocco motore

215 046 02 Perni blocco camme

### Kit messa in fase Alfa Mito 1.4 - 16V

Engine timing tool  
Alfa mito 1.4 - 16V



215 047 in valigetta

Motori: 199 A 6000 / 199 A 8000 / 955 A 8000

#### Ricambi - Spare-parts



215 026 Coppia di attrezzi bloccaggio alberi a camme



215 027 01 Attrezzo blocco puleggia distribuzione



215 158 01 Staffa blocco albero a motore



215 610 Attrezzo rotazione tenditore

### Kit messa in fase motore 1.9 JTD 16V

Engine timing tool set 1.9 JTD 16V



215 048 Alfa 159 - Fiat Nuova Croma

#### Ricambi - Spare-parts



215 048 01 Staffa blocco albero motore



215 048 03 Staffa blocco volano



215 076 00 Perno blocco albero a camme

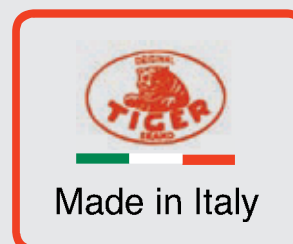

www.afasupport.it



**Kit messa in fase Fiat Croma - Alfa 159 1.8 16V**

Kit canshaft regulation Fiat Croma-Alfa 159 1.8 16V

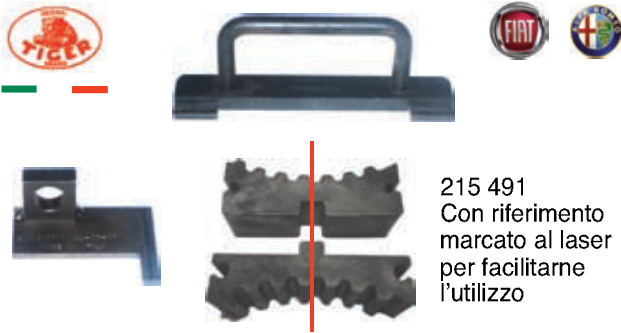

215 491  
Con riferimento  
marcato al laser  
per facilitarne  
l'utilizzo

215 049 Kit in valigetta

**Ricambi - Spare-parts**



215 049 01 Attrezzo ferma volano



215 049 02 Staffa blocco alberi a camme



215 491 Attrezzi blocco pulegge alberi a camme

**Settore graduato messa in fase motore**

Jig for ignition timing



215 050 Universale - Diam. 130 mm

215 051 Universale - Diam. 240 mm

**Spina per messa in fase albero motore**

Retainer for flywheel



215 053 Citroen 1.9 D

**Perni per messa in fase puleggia iniezione**

Nuts for retain injection pump



215 054 Citroen 1.9 D

**Attrezzo mantenimento P.M.S. sul 1° cil.**

Retainer for T.D.C. on first cylinder

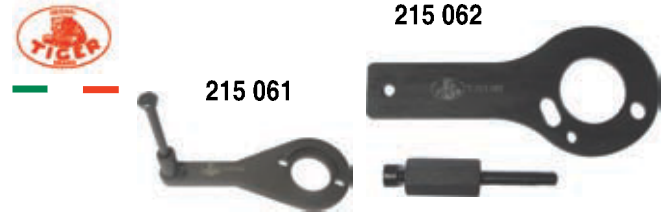

215 061 Mot. Fiat 1697 D-1929 D

215 062 Mot. 1910 D TD - 1910 JTD - 2387 TD-JTD

**Kit messa in fase cinghia distribuzione Multiair 1.4**

Timing tool for Fiat Multiair 1.4

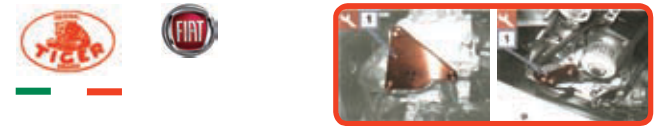

215 068

**Ricambi - Spare-parts**



215 068 01 Piastra blocco albero a camme



215 158 01 Staffa albero motore

**NOTE**





**Kit messa in fase cinghia distribuzione Twin Air**

Timing tool for Twin Air



215 069 in valigetta

**Ricambi - Spare-parts**



215 069 01 Piastra albero a camme



215 069 02 Perno blocco albero motore



215 069 03 Perno fasatura puleggia

**Confezione per messa in fase motore**

Tool for camshaft regulation



215 070 Motori DIESEL 1697D - TD 1929 D - TD 1910D - TD 1910 JTD - 2387 TD JTD

**COMPOSIZIONE**

- 215 061 Mot. Fiat 1697 D-1929 D
- 215 062 Mot. 1910 D TD - 1910 JTD - 2387 TD-JTD
- 215 071 Mot. Fiat 1697 D-TD 43.5°
- 215 072 Mot. Fiat 1929 D 42.5°
- 215 073 Mot. Fiat 1929 TD 41.5°



**Confezione per messa in fase motori Fiat Multijet 1.3**

Tool for camshaft regulation



215 075  
Kit completo

**Ricambi - Spare-parts**



215 075 01 Coppia blocco alberi a camme



215 075 02 Blocco albero motore perno 10 mm



215 075 03 Tendicinghia



215 075 04 Blocco volano



215 075 05 Perno Ø8 blocco volano



215 139 03 Perno Ø6 blocco volano

**Kit messa in fase motori 1.9 cc Multijet**

Timing tool for Multijet 1.9



215 076 In blister

**Ricambi - Spare-parts**

215 062



215 075 04



215 076 01



215 139 03



**Kit messa in fase motori 1.3 e 1.9cc Multijet**

Timing tool for camshaft regulation



215 076 10 In valigetta

**Ricambi - Spare-parts**



215 062 Staffa blocco albero motore



215 075 01 Coppia blocco alberi a camme



215 075 02 Blocco albero motore (perno mm10)



215 075 03 Tendicinghia



215 075 04 Blocco volano



215 075 05 Perno Ø8 blocco volano



215 076 01 Coppia perni albero a camme



215 139 03 Perno Ø6 blocco volano

**Kit messa in fase motori 1.6 cc Multijet**

Engine timing tool set 1.6 Multijet

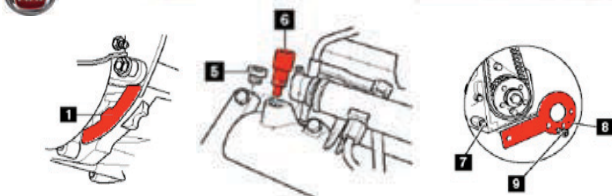

215 076 50 In valigetta

**Ricambi - Spare-parts**



215 048 01 Staffa blocco albero motore



215 076 00 Perno blocco albero a camme



215 076 55 Staffa blocco volano

**Adattatori opzionali per nostri art: 215 075 & 215 076 10 da utilizzare su versioni particolari di motori 1.3 Multijet**



215 076 56 Perno blocco volano mm 9 x100

Perno mm 9



215 076 57 Staffa blocco albero motore

**Kit messa in fase motori VW Polo 1.2**

Timing tools VW - Polo 1.2



215 077 3 Cilindri / 12 Valvole in blister

**Ricambi - Spare-parts**



215 077 01 Coppia attrezzi alberi a camme



215 077 02 Perno blocco albero motore

**Kit messa in fase motori VW Polo 1.2**

Timing tools VW - Polo 1.2



215 078 3 Cilindri / 6 - 12 Valvole - Kit in valigetta

**Attrezzo fasatura pompe iniezione**

Tool for injection pump regulation



215 079 Pompe Lucas su Kangoo, Doblò e Mercedes

**Attrezzo mantenimento fase pompa iniezione**

Tool for checking the delivery injection pump



215 080 Mercedes 190 D-C 220 D

**Perni blocco alberi a camme motori Mercedes Classe A**



215 081

**Blocco albero a canne**

Clamp for stroke checking



215 082

BMW 316 - 318 -Z3 - 750 - 850 - Motori 16 4E 2 (E30-E36) / 18 4E 2 (E28-E36) / 19 4E 2 (M43) - 50 12A (M70) / 56 12 1 (S70) / 54 12 1 - 54 12 2 (M73)

**Blocco albero a canne**

Clamp for stroke checking



215 083

BMW 318 TDS - 325 TDS - 525 TD-TDS - 725 TDS - Motori 17 4T 1 (E36) / 25 6T 1 (E39-E34-E38)

215 084

BMW TD 524 vecchio modello

**Kit fasatura motore BMW tutti i modelli benzina doppio albero a camme con testata singola**

Kit for stroke cheking BMW duoble camshaft



215 085

BMW 318-320-323-328-520-523-525-528-728-Z3 - Motori 18 4S 1 / 19 4S 1 / 20 6S 2 / 25 6S 1 / 25 6S 2 / 20 6S 3 / 25 6S 3 / 28 6S 1 / 20 6S 4 / 25 6S 4 / 28 6S 4 / 28 6S 2.

**Attrezzo fasatura contralberi motore BMW 318 IS**

Kit for phase contrarbor motor BMW 318 IS



215 085 01

**Kit in valigetta per fasatura motore BMW**

Kit for phase motor BMW

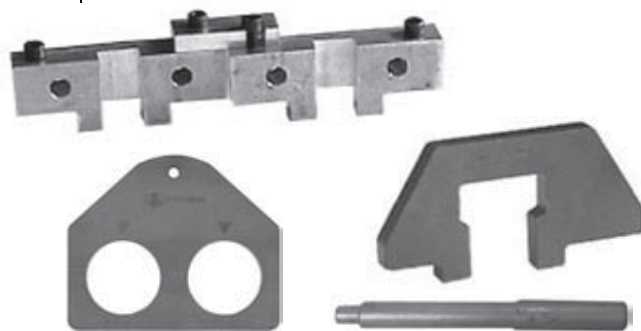

215 085 10

BMW 316-318-320-323-325-520-523-525-528-725-728-Z3 (Per motori vedi 215 082 e 215 085)

**Kit messa in fase pompa iniezione e alberi controrotanti per BMW N 47 (utilizzabile solo in abbinamento a nostro 21508515)**

Timing tool for BMW N 47

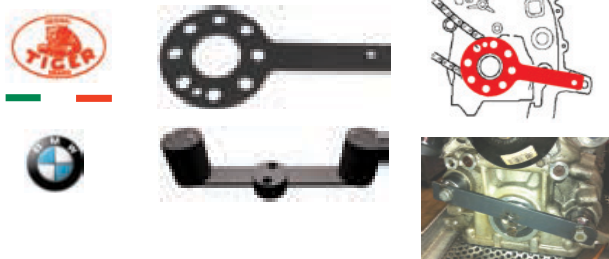

215 085 12 In blister

**Kit messa in fase motori BMW 2.0 N47 - N47s (DV20A / B)**

Engine timing tool set 2.0 BMW



215 085 15 In valigetta

NOTE



---



---



---



---



---



---



### Kit messa in fase motori BMW 2.0

N47 Engine timing tool set 2.0 BMW



215 085 19 215 085 12 + 215 085 15 - In valigetta

#### Ricambi - Spare-parts



215 085 13 Fase pompa iniezione



215 085 14 Fase alberi controrotanti



215 085 16 Piastra blocco alberi a canne



215 085 17 Chiave rotazione motore



215 086 01 Perno blocco albero motore

Per modelli:

118d. E81-87 (06-09) / 120d. E81-82-87 (06-09)  
 123d. E81-82-87 (07-09) / 318d. E90-91 (07-09)  
 320d. E90-91-92 (05-09) / 520.d E60-61 (06-08)  
 x3 2.0d. E8 (07-09)

### Kit messa in fase motori Bmw M60 & M62

Kit for Bmw engine models M60 & M62



215 085 20 in valigetta

### Staffa riscontro fase motori BMW M47 - M57

Wrench test distribution BMW M47 - M57 motors



215 086 Kit completo x BMW 320d/330d/530d/730d - Motori 20 4d 1 (M47) / 30 6d 1 (M57)

#### Ricambi - Spare-parts

215 08601 Perno blocco volano

### Estrattore pompa iniezione BMW M47 - M57

Tool for injection pump BMW M47 - M57



215 087 10 Kit completo - 215 087+215 087 01+215 087 02

#### Ricambi - Spare-parts

215 087 Estrattore/Puller/Extractor

215 087 01 Ghiera di supporto estrattore - 42x1.5

215 087 02 Ghiera di supporto estrattore - 40x1.5

### Estrattore pompa iniezione CP4

Tool for injection pump CP4



215 087 50 BMW serie 1 n 47

### Estrattore per pompa iniezione BMW con ingranaggio avente filetto maschio

Tool for injection pump BMW



215 088

**Kit registro fasatura motori BMW M52 - M54 - M56**



**215 089** Kit Completo - Motori 20 6S 4 / 25 6S 4 / 28 6S 4 / 28 6S 2

**215 089 01** Piastra alluminio per allineamento pulegge

**215 089 02** Piastra teflon allineamento ruota fonica.

**Kit attrezzi per fasatura distribuzione motori BMW N42 - N46 - N46T**

Timing tool set for Professional Engine Repair



**215 089 10**

**Modelli Vetture BMW:**

<b>E87</b>	118i / 120i - Motore N46
<b>E46</b>	316i / 316ti / 318i / 318ti - Motore N42
<b>E46</b>	316i/316ti/318ti- Motore N42
<b>E90 / E91</b>	318i / 320i - Motore N46
<b>E85</b>	Z4 , 2,0l - Motore N46

**Kit registro fasatura motori benzina) Bmw N62 / N73**

BMW input / output camshaft alignment tool set



**215 089 20**

in valigetta



**Kit registro fasatura motori benzina Bmw N52**

Engine timing tool set for repair BMW N52



**215 089 30**

in valigetta



**Kit messa in fase Bmw N51 / N52 / N53 / N54**

Engine timing tool set for N51 / N52 / N53 / N54



**215 089 40**

in valigetta



**Per modelli:**

128i - E82 (07-08), 130i - E81/E87 (05-08), 135iS. E82 (07-08), 323i - E90/91/92/93 (04-08), 325i / xi - 330i/ xi - 335i / xi - 523i / Li - E60/61 (04-08)X3 - 2.5 / 3.0 E83 (06-08), Li / 525i / xi - E60/61 (06-08), 630i - E60/61 (04-08), 528i / Li / xi - E60/61 (06-08), 530i / Li / xi - E60/61 - (05/08), 535i / xi - E63/64 (04-08), 730i / Li - E65/66 (04-08), X5 3.0 - E70 (06-08), Z4 2.5 / 3.0 - E85/86 (05-08) - 328i E90/91/92/93 (04-08) xi

**Kit messa in fase Bmw N40 / N45 ( T )**

Kit messa in fase Bmw N40 / N45 ( T )



**215 089 50**

in valigetta



**Per modelli:**

1 serie 116 E81 / E87 - 3 serie 316i E46 / E90 - 316 CI E46 316 TI E46

**Staffa ritegno puleggia distribuzione per messa in fase**



**215 091** Audi D

**Staffa ritegno puleggia distribuzione per messa in fase**



**215 092** Fiesta D

**Perno di riscontro fase precamera**

Pin for stroke checking



**215 105** Mot. 1930 D

**Attrezzo per smontaggio e rimontaggio pompa VP per motori Ford Duratorq 2.0, 2.2 e 2.4**

Set for assembly / disassembly Vp pump on engine Ford Duratorq 2.0, 2.2, 2.4



215 108

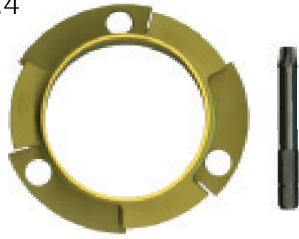

**Attrezzo smontaggio pompa iniezione dall'ingranaggio di comando**

Tool for dismounting Injection pump



215 110 Ford 1600 D

**Staffa ritegno puleggia distribuzione per messa in fase**

Timing tool for camshaft regulation



215 112 Alfa 90 alfetta Motronic

**Chiave ghiera fissaggio ingranaggio distribuzione**

Wrench for distribution nut



215 113 Alfa 90 Alfetta Motronic 55 mm

**Chiave per smontaggio variatore di fase albero distribuzione**



215 114 Alfa 90 Alfetta Motronic 58 x 52 x 4,5

**Chiave per variatore fase albero distribuzione**

Wrench for valve timing device on camshaft



215 115 Alfa 90 Alfetta Motronic 42 x 36 x 4,5

**Kit messa in fase motori Chrysler 2.5 - 2.8**

Kit for camshaft regulation Chrysler motors 2.5 - 2.8



01

02

03

04

215 117 Kit completo Voyager - Cherokee - Pz 4

**Ricambi - Spare-parts**

215 117 01 Spina singola

215 117 02 Spina singola

215 117 03 Spina singola

215 117 04 Spina singola

**Estrattore per puleggia ventola**

Puller for fan coil pulley



215 118 Alfa 164 2.5 Td

**Kit per la messa in fase motori Citroen - Peugeot**

Kit canshaft regulation engine Citroen - Peugeot

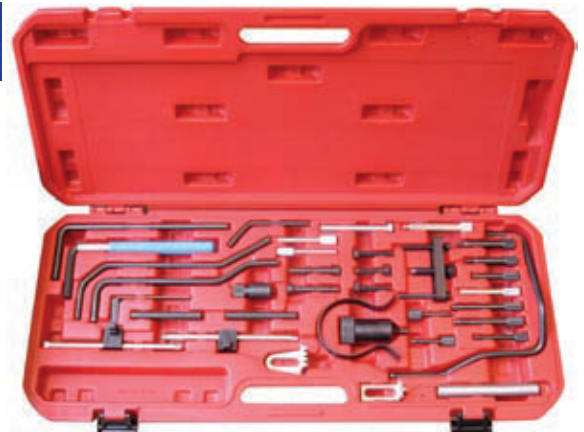

215 119

CITROEN: AX - Berlingo - BX - C5 - C15 - C25 - Dispack - Evasion - Jumper - Jumpy - Relay - Saxo - Synergie - Visa - Xara - Xantia - Xm - XJR - ZX

PEUGEOT: 106 - 205 - 306 - 405 - 406 - 605 - 806 - J5 - Boxer - Expert - Partner - Solara - Talbot Express - Talbot Horizon





### Kit messa in fase motori Citroen - Peugeot

Engine timing tool set - Citroen - Peugeot



215 119 01 Motori 1.4 - 1.6 HDI - 2.0 16V Bz

### Confezione per messa in fase motore

Tool for camshaft regulation



Particolare Spina mm 6

215 120 **Citroen-Peugeot-Renault-Rover**  
Ricambi contenuti

#### Ricambi - Spare-parts

- 215 121 Attrezzo fermo / Pin / Eje 7.5 - 8 mm
- 215 121 01 Attrezzo fermo / Pin / Eje 6 mm
- 215 122 Coppia spine / Twin pins / Doble eje 6.6 mm
- 215 123 Coppia viti /Twin bolts/Doble tuercas 6x1 - 55 mm
- 215 124 Tre viti / Tree bolts / Tres tuercas 8x1.25 - 50 mm

### Kit messa in fase motori Audi - Ford - Vw - Volvo e motori Zetec

Tool for camshaft regulation engine Audi - Ford - Vw - Volvo & motori Zetec



Novità  
inclusa



215 125 Questa composizione sostituisce quella precedente

#### Ricambi - Spare-parts

- 215 100  Spina Golf Diesel Ø 15.4
- 215 101  Spina Ford Diesel Ø 6
- 215 102  Spina Ford Zetec 1.2 - 1.4 - 1.6 - Ø 5

215 104  Spina Ford 1.8 - 2.0 16V

215 126  Staffa di fermo albero a camme

215 127  Coppia di spine Ø 6

215 128  Spina Ø 8.25

215 129  Spina Ø 9.5

215 130  Spina Ø 12.7

215 131 01  Spina Ford blocco - volano Ø 9

215 131 02 Spina Ford blocco - volano Ø 13

215 133  Staffa di fermo albero a camme

510 414  Spessimetri 0.05 - 1.00 - 20 Lame

### Coppia di spine per blocco volano motori Ford 1.4 TDCi - 2.0 - 2.4

Pin couple for fly-wheel block engine Ford

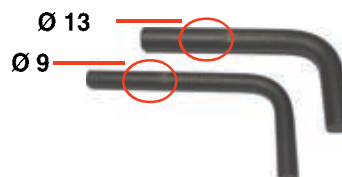

215 131 Spina Ø 9 + Spina Ø 13

#### Ricambi - Spare-parts

- 215 131 01 Spina singola Ø 9
- 215 131 02 Spina singola Ø 13

### Kit messa in fase motori Ford 1.4 - 2.0 - 2.4

Engine timing tool set Ford 1.4 - 2.0 - 2.4



215 132 in valigetta

**Kit per la messa in fase dei motori Ford**

Timing tool set for Ford



215 133 10 Fiesta - Fusion 1.2 / 1.4 / 1.6  
Focus - C Max 1.4 / 1.6

**Kit fasatura distribuzione motori Ford Focus e CMax**

Timing tool set for Focus e CMax



215 133 20

**Dati tecnici - Informative**

I cinque particolari del kit sono essenziali per la messa in fase dei motori Ford Focus / CMax  
1.6 Ti-VCT con codice motore HXDA (03/07)  
2.0 TDCI con codice motore G6DA-G6DB-G6DC (03/07)

**Kit messa in fase motori Ford Duratorq Diesel 2.0 - 2.2 - 2.4**

Tool kit Diesel 2.0 - 2.2 - 2.4 TDDI - TDCI



215 134

**Confezione messa in fase motori: Fiat 4HV; Peugeot P22DTE (4HV - 4HU) 2.2 TDCi - HDI**

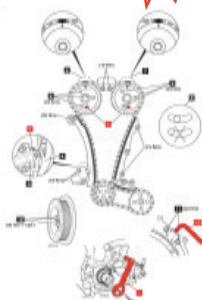

215 134 10 Kit completo in blister

**Ricambi - Spare-parts**

- 215 131 02 Perno blocco volano motore
- 215 139 03 Perno blocco pulegge camme ( 2Pz )
- 215 155 03 Perno blocco tenditore catena
- 215 134 11 Staffa blocco motore

**Kit messa in fase cinghia distribuzione motore Ford 1.4 TDCi / 1.6 TDCi e Citroen / Peugeot 1.4 HDI**

Timing tool for 1.4 & 1.6 TDCi & Peugeot 1.4 HDI



215 134 20 In blister

**Ricambi - Spare-parts**

- 215 134 21 Perno albero motore
- 215 134 22 Perni puleggia camme e pompa gasolio
- 215 134 23 Perno ghiera posteriore puleggia

**Attrezzo mantenimento in fase pulegge distribuzione**

Tool for camshaft regulation

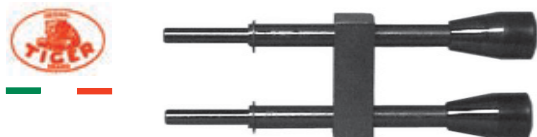

215 135 Motor/Engine VW 1.4 16V - 1.6 16V

**Attrezzo blocco albero a camme per fase motori Audi A3 e Golf IV**

Wrench for block distribucion Audi A3 and Golf IV

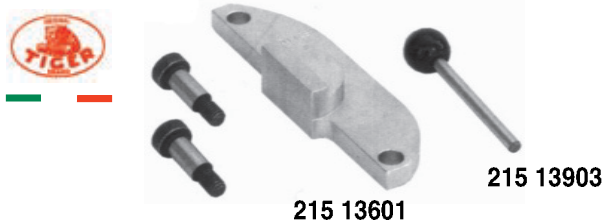

215 136 Kit completo

**Ricambi - Spare-parts**

- 215 136 01 Staffa
- 215 139 03 Perno blocca puleggia

**Attrezzo blocco Albero a camme motori Audi 5 cilindri TDI e furgoni VW LT**

Wrench to block camshaft Audi 5 cylinder TDI and VW LT

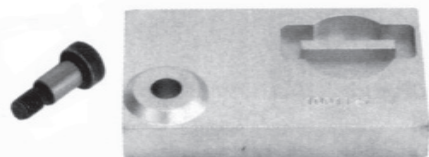

215 137

**Attrezzo blocco alberi a camme motori VW-Seat-Skoda V6 TDI**

Block camshaft tool for VW-Seat-Skoda V6 TDI motors



215 139 Kit Completo

**Ricambi - Spare-parts**

- 215 139 01 Particolare 1 - Coppia staffe
- 215 139 02 Particolare 2 - Perno blocco albero motore
- 215 139 03 Particolare 3 - Perno forato

**Kit montaggio organi distribuzione composto da staffa bloccaggio doppio albero a camme e perno per rilevamento P.M.S.**

Kit for camshaft regulation with tool for locking double camshaft and pin for checking T.D.C.

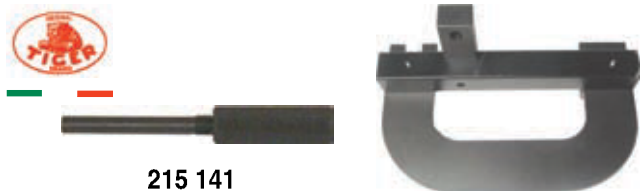

215 141

Perno utilizzabile anche per motori Diesel

215 142

215 140 Kit completo - Renault Mot. 1.4-1.6-1.8-2.0 16V

**Ricambi - Spare-parts**

- 215 141 Perno di ricambio - Renault Mot. 1.4-1.6-1.8-2.0 16V
- 215 142 Staffa di ricambio - Renault Mot. 1.4-1.6-1.8-2.0 16V

**Perno per la messa in fase motori Renault DCI 1.5**

Tool for deterring TDC Renault 1.5 DCI

215 141 01



**Kit fasatura distribuzione motori Renault 2.0 F5R**

Timing tool set for Renault 2.0 F5R Model



215 141 10

**Allineamento puleggia alberi a canne**

Tool for camshaft regulation



215 143 Motor/Engine Renault - 1.4 - 1.6 16 V

**Attrezzo fasatura pompa iniezione motori Renault 1.9D**

Kit check pumps injection motor Renault 1.9D



215 144 01

**Attrezzo bloccaggio ruota dentata pompa iniezione motori Renault 1.9D**

Kit block cogwheel it pumps injection motor Renault 1.9D



215 144 02

**Chiave ritegno ingranaggio pompa olio motori Renault Scenic - Clio e megane 1.6 - 8 valvole**



215 144 05

**Attrezzo blocca pompa iniezione Renault 1.9 TDI**

Tool for Renault 1.9 TDI



Clio - Megane - Laguna Kangoo

215 144 10 in blister



NOTE





**Kit messa in fase motori Renault 2.2 Dci e 2.5 Dci**

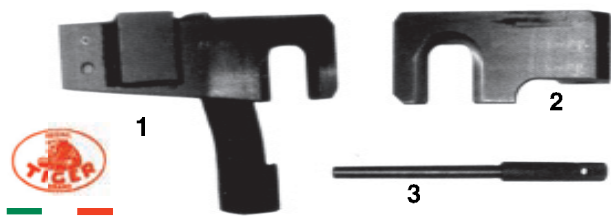

215 145 Kit Completo

**Ricambi - Spare-parts**

- 215 145 01 Staffa Blocco cam aspirazione 1
- 215 145 02 Staffa Blocco cam scarico 2
- 215 145 03 Perno blocco albero motore 3

**Kit messa in fase motori Renault 2.2 Dci e 2.5 Dci**

Kit for camshaft regulation Renault 2.2 Dci and 2.5



215 145 10

**Piastra allineamento puleggia alberi a camme motori Renault DCI 1.5 - 1.9**

Tool to lock driving pulley while setting



215 146

**Kit messa in fase motori Renault**

Timing tools Renault

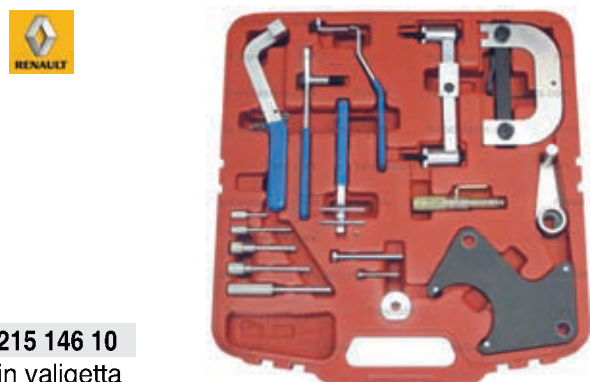

215 146 10  
in valigetta

**Dati tecnici - Informative**

- Twingo 1.2
- R19 + Express + Extra + Rapid 1.4
- Scenic 1.4/1-6/2-0 16V
- Laguna 1.6 16V - 1.8+2.0 - 1.8+2.0 16V - 2.2D/TD - 2.5D/Td
- Safrane 2.0 16V - 2.2 Td - 2.5 20V
- Clio 1.2/1.4 - Clio 1-4/1.6/1.8/ 16V - Clio sport 2-0 16V
- Master 2.5 D/Td
- Trafic 2.5D -
- Espace2.0 - 2.0 16V - 2.2Td

**Kit messa in fase alberi a camme 2.0 DCI**

Tool to lock driving pulley while setting 2-0 Dci

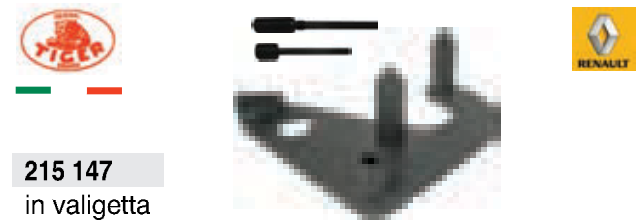

215 147  
in valigetta

**Ricambi - Spare-parts**

- 215 147 01 Perno blocco albero motore
- 215 147 02 Perno blocco ingranaggio in 2 pezzi albero a camme aspirazione
- 215 147 03 Piastra blocco puleggie distribuzione

**Attrezzo estrazione pompa iniezione e mantenimento ingranaggio distribuzione motori Renault 2.2 e 2.5**

Set for extraction and maintenance of distribution gear on engine Renault 2.2 & 2.5



215 148

**Kit messa in fase motori GM ecotech 2.0**

Engine timing tools Seat - VGA



215 149

**Kit montaggio distribuzione OPEL 2.0 TD 16V**

Assembling tool for crunkshaft OPEL 2.0 TD 16V



215 150 Kit completo in valigetta

**Ricambi - Spare-parts**

- 215 151 Piastra bloccaggio camme
- 215 152 Perno bloccaggio abero motore
- 215 153 Perno bloccaggio pompa iniezione

**Kit messa in fase motori Diesel 1.7 Opel & Isuzu**

Engine timing tools set Diesel 1.7 Opel & Isuzu

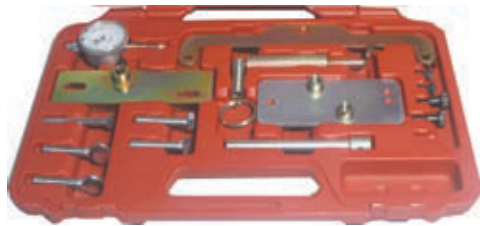

215 154 in valigetta

**Kit messa in fase motori Opel 1.0 - 1.2 16V - 1.4 16V**

Kit test distribuccion opel 1.0 - 1.2 16V - 1.4 16V motors



215 155 Kit Completo in valigetta

**Ricambi - Spare-parts**

- 215 155 01 Particolare 1 - staffa ruota fonica
- 215 155 02 Particolare 2 - perno blocco albero motore
- 215 155 03 Particolare 3 - Ø 2 mm - perno blocco tenditore
- 215 133 Particolare 4 - staffa blocco alberi a canne

**Kit messa in fase motori 2.2 16V**

Petrol 2.2 16V (chain) Timing + Water pump tool set



215 156 Opel Astra - Vectra - Zafira - VX 220 - Signum

**Kit messa in fase albero motore FIAT EVO 2 - 8V**

Engine timing tool set Fiat EVO 2 - 8V



215 158 00  
motori  
1.2 8V  
1.4 8V  
in valigetta

**Ricambi - Spare-parts**



215 158 01 Staffa blocco albero motore



215 158 02 Staffa messa in fase albero a camme



215 158 03 Piastra posizionamento coperchio testa cilindri



215 158 04 Staffa reazione puleggia distribuzione 1.4 8V

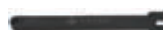

215 610 Attrezzo per rotazione tenditore cinghia distribuzione

**Piastra bloccaggio albero distribuzione**



215 161 Opel 1.6 Diesel - Corsa - Kadett - Vectra

**Piastra messa in fase albero distribuzione**



215 163 Opel astra 1.7 D - Da utilizzare con 214 226

**Kit fase motori AUDI AJM 115-130-150 CV**

Tool for setting crunkshaft AUDI AJM 115-130-150 CV



215 139 03



215 580



215 497



215 632 01

215 165 in valigetta

NOTE



**Kit messa in fase motori Audi / Skoda / Vw**

Timing tool set for engine Audi / Skoda / Vw



215 166

**Ricambi - Spare-parts**



215 497 Staffa blocco albero motore 1.4 - 1.9 TDI



215 498 Staffa bolocco albero motore 2.0 TDI



215 498 01 Coppia di perni blocco puleggia distribuzione



215 498 02 Spine ritegno tendicinghia

215 580 Piastrina ritegno tendicinghia



215 632 01 Chiave tendicinghia

**Kit messa in fase motori 2.0 TDI - Audi A4, A6 - Skoda Octavia - Vw Golf, Golf Plus, Jetta e Touran**

Timing tool set for VAG 2.0 TDI



215 167  
Kit 6 Pz

**Ricambi - Spare-parts**



215 497 Staffa blocco albero motore Vw 1.4 - 3 Cil 1.9 D - AJM



215 498 Staffa bolocco albero motore 2.0 TDI



215 498 01 Coppia di perni blocco puleggia distribuzione



215 498 02 Spine ritegno tendicinghia

**Kit messa in fase motori Audi - Volkswagen - Skoda - 1.4 - 1.6 FSI - TSI**

Petrol engine twin camshaft setting / locking tool kit

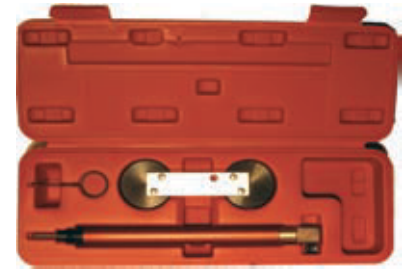

215 168

**Kit messa in fase catena nella testata, Audi e Vw 2.0 FSI / TFSI**

Petrol engine twin camshaft setting tool kit



215 169  
in valigetta

Audi: A3 2.0 FSI (03)  
Audi: A4 2.0 TFSI (04)  
Audi: A6 2.0 TFSI (06)  
Vw: Golf, Touran 2.0 FSI (03), Passat 2.0 TFSI (05)

**Kit fase VW VGA - 2.4D**

Engine timing tools for Vw VGA - 2.4D



215 170

**Dati tecnici - Informative**

- Anno 02 / 1995 - 2003

Motori AAB - AJA

**Kit messa in fase Land Rover - Jaguar**

Land Rover / Jaguar engine timing tools kit



215 175  
in valigetta - Pz 5

**Dati tecnici - Informative**

Rover discovery 2.7TD V6 - Range Rover Sport 2.7TD V6  
Jaguar TD V6



**Kit messa in fase alberi a camme su motori Volvo 850-960-S40-S70-S90**



**215 180**  
In valigetta

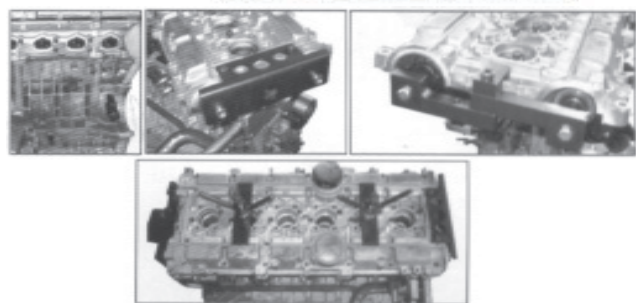

**Kit messa in fase Vw - Audi - Seat 1.8**

Volkswagen timing tool



**215 200**  
in blister5

**Dati tecnici - Informative**

Audi: A3 - S3 - A4 - A6 - TT  
Seat: Ibiza - Cordoba . Leon - Toledo - Alhambra  
Skoda: Octavia  
Vw: Golf - Bora - Beetle - Passat

**Kit in valigetta fasatura distribuzione per una larga gamma di motori Mercedes sia diesel che benzina e motori Chrysler 2.2 CRD e 2.7 CRD**

Timing tool set for Mercedes and Chrysler 2.2 / 2.7



**215 470**

**Kit fasatura distribuzione per motori Audi 100 e A6 con motore Z15L TDI e VW Polo Diesel.**

Timing tool set for Audi 100 and A6 Z15L motor - VW Polo Diesel



**215 474**

**Kit fasatura motori Bmw-Mini / Citroen / Peugeot**

Petrol engine twin camshaft setting/locking tool



**215 477**  
in valigetta

- BMW MINI - CITROEN - PEUGEOT (1.4 / 1.6 16V valvetronic)
- Bmw mini: R55 - R56 COOPER S
- Bmw mini: R55 - R56 COOPER
- Bmw mini: R56 MINI ONE
- Citroen: C4 - C4 Picasso
- Peugeot: 207 - 308
- Bmw: N12 ( 1.4 - 1.6)
- Bmw: N14 ( 1.6)
- PSA: EP3 - EP6 - EP6DT - DTS

**Kit fasatura distribuzione per BMW Mini**

EngineTiming Tool Kit for BMW Mini



**Per motori:**  
8 Valvole

**215 478** In valigetta

**Dati tecnici - Informative**

- Anno 2001-06 Mini cooper W10B16AA
- Anno 2001-06 Mini cooper S W10B16BA
- Anno 2002-06 W11B16AA

**Kit fasatura distribuzione per BMW Mini One**

EngineTiming Tool Kit for BMW Mini One



**Per motori:**  
8 / 16 Valvole

**215 479**  
in valigetta

**Dati tecnici - Informative**

- Anno 2001-06 Mini One W10B16AA
- Anno 2001-06 Mini cooper W10B16BA
- Anno 2002-06 Mini Cooper W11B16AA
- Motore N 14

**kit universale estrazione pulegge - Poly V**

Universal pulley puller set



215 480

**Blocca puleggia universal**

2 Way universal timing belt locking tool

215 484 in valigetta



**Attrezzo universale bloccaggio pulegge distribuzione con 4 settori dentati orientabili.**

Universal tool for block camshaft wheel.

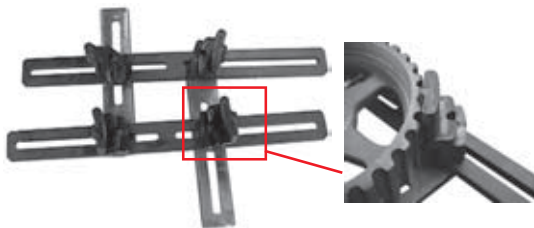

215 485 Kit composto da 4 staffe corte e 2 lunghe

**Kit estrazione pulegge VW Audi**

EngineTiming Tool Kit for BMW Mini



215 486 Per motori Audi - Vw - 4 e 6 cilindri

**Estrattore pulegge con 8 fori a losanga per viti M8 & M10**

Extractor pulleys with 8 holes for M8 & M10 screw



215 487 Ø100 - utilizzabile con 3, 4 o 6 viti Ford Fiesta

**Estrattore puleggia albero motore Ford Focus**

Extractor for Ford Focus camshaft pulley



215 488

Ø 80 - 4 piedini

**Attrezzo bloccaggio volano motore Ford**

Block wheel for Ford



215 489

**Kit attrezzi bloccaggio pulegge distribuzione motori**

Driving pulley retainer tool kit



215 490 Kit completo

215 490 01 Giallo/Yellow/Amarillio - OPEL 16V 1800/2000

215 490 02 Blu - OPEL 16V 1400/1600

215 490 03 Verde/Green/Vierde - OPEL V6 2500/3000

215 490 04 Rosso/Red/Roco - OPEL V6 2500/3000

215 490 05 Grigio/Gray/Gris - SAAB - 900/900 0

215 490 06 Nero/Black/Negro - ROVER - Tipo K16

**Attrezzo blocco pulegge alberi a camme - 1.8 - 16V**

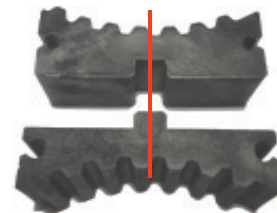

215 491

Con riferimento marcato al laser per facilitarne l'utilizzo

**Kit attrezzi bloccaggio pulegge e volano su motori Opel - Saab - Rover - Isuzu - VW**

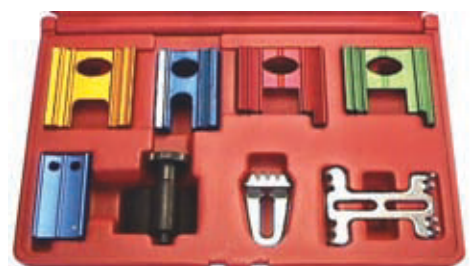

215 492

in metallo

**Staffa blocco albero motore VW 1.4 TDI - 1.9 TDI**

Stirrup block camshaft VW 1.4 TDI - 1.9 TDI



215 497

Vedi Kit 215 165 / 215 166 / 215 167

**Staffa blocco albero motore 2.0 TDI**



215 498

**Coppia perni blocco tenditori cinghia distribuzione**



215 498 02

**Attrezzo per fermo puleggia albero motore**

Tool for retaining crankshaft pulley



215 501 Alfa 164 2,5 TD

**Attrezzo per fermo albero distribuzione durante smontaggio albero motore**

Tool for retaining crankshaft during dismounting



215 502 Audi 5 cil. da usare/use with/con 215 520

**Attrezzo per fermo albero distribuzione durante smontaggio albero motore**

Tool for retaining crankshaft during dismounting



215 503 Audi 6 cil. da usare/use with/con 215 520

**Attrezzo per fermo albero distribuzione durante smontaggio albero motore**

Tool for retaining crankshaft during dismounting



215 504 Audi 6 cil.mot. WOS da usare conr/use with/ con 215 524

**Chiave tensionamento puleggia organi ausiliari**

Wrench for tensioning auxiliary



215 510 Marea-Marea week end 2400 D - 32 mm

**Chiave smontaggio puleggia albero motore BMW con dump (antivibrazione)**

BMW key crankshaft pulley removal with dump



215 515

mm 350



215 516

mm 345



	A	B	C
	Ø est.	Ø int.	Dente
215 515	63,5	57,3	15
215 516	68,5	57,5	15

**Chiave dado fissaggio puleggia albero motore**

Wrench for nut fixing pulley on crankshaft



- 215 520 Audi - 27 mm
- 215 521 Uno 60/70/turbo ie-Ritmo 60/ES/70/85-Regara 70/ES/-75/85 - 30 mm
- 215 522 Fiat 126-900T-Panda 30-Punto 1108/1242 SPI/ MPI - 32 mm
- 215 523 Fiat 124 Spider-125 - 34 mm
- 215 524 Audi mot. 6cil-127-Panda 45-131 D- Punto 1372 Turbo - 36 mm
- 215 525 127 - 1050 - 128 - Ritmo - 131B - 132B - Campagnola - Ritmo - D-Uno 60/70 Turbo ie Regata 70ES/75/85 - 38 mm



**Chiave dado fissaggio puleggia albero motore**

Wrench for nut fixing pulley on crankshaft



215 530 Alfa sud-Arna-33 - 27 mm

**Chiave dado fissaggio puleggia albero motore**

Wrench for nut fixing pulley on crankshaft



215 540 Kappa - 19 mm

**Attrezzo per smontaggio pulegge multigola poliv**

Pulley removing wrench

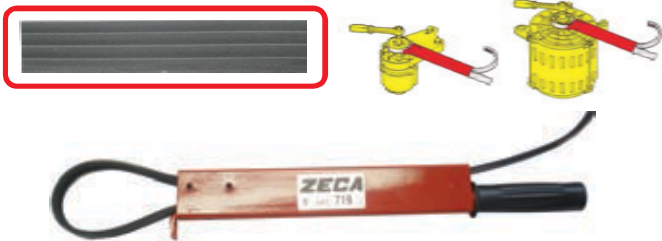

215 543 Zeca 719

**Attrezzo bloccaggio puleggia trapezoidali**

Tool locking pulley



215 544 Universale

**Attrezzo bloccaggio puleggia distribuzione**

Tool locking camshaft pulley



215 545 Alfa Sud-33

**Attrezzo rotazione organi distribuzione motori con 4 perni riposizionabili**



215 548

**Kit completo per flange rotazione motori Fiat**

Universal tool locking camshaft pulley

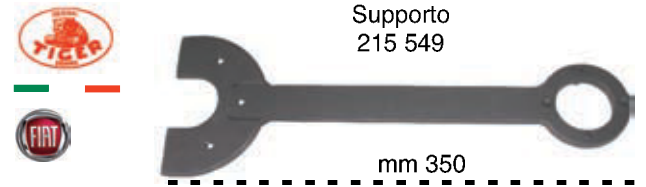

Flangia 215 550 Flangia 215 551 Flangia 215 552



Flangia 215 553 Flangia 215 554

215 555 Kit completo in valigetta

**Ricambi - Spare-parts**

- 215 549 Supporto
- 215 550 Flangia Lancia Kappa- 164 24 V - Multipla Bipower
- 215 551 Flangia Bravo - Brava - 145 - 146
- 215 552 Flangia Coupè - Barchetta - 146 2000 cc
- 215 553 Flangia Marea Week-end 1910-2400cc
- 215 554 Flangia rotazione puleggia distribuzione motori Multijet

**Attrezzo rotazione organi distribuzione motori Ford**

Key rotation distribution Ford Motor



215 558 con perni Ø 17 mm

**Attrezzo rotazione organi distribuzione motori NISSAN - TOYOTA**

Key rotation distribution NISSAN - TOYOTA Motor



215 560

**Attrezzo rotazione organi distribuzione motori TOYOTA e LEXUS**

Key rotation distribution LEXUS - TOYOTA Motor



215 562

**Attrezzo per tensionamento cinghia dentata comando distribuzione**

Devices for tension of toothed timing belt

perno filettato m 8x1,25

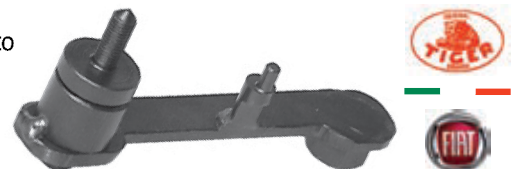

215 570 Bravo-Brava 1581 16v

### Attrezzo tendicinghia motori Fiat 1.6 16V

Tool for tension of toothed timing belt

perno filettato  
m 10x1,25



215 571 Fiat Multipla Bipower - Fiat Stilo

### Perno filettato M10x1.25 per Multipla Bipower e Stilo

Tool for Fiat Multipla Bipower and Stilo



215 571 01 intercambiabile all'attrezzo art.215 570

### Attrezzo tendicinghia femmina per motori Alfa Romeo

ool female for timing belt tension

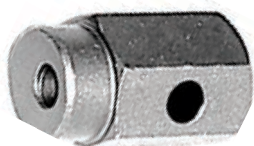

215 572 Alfa Romeo

### Attrezzo tendicinghia maschio per motori Alfa Romeo

Tool male for timing belt tension



215 573 Alfa Romeo

### Attrezzo tendicinghia motori Renault Megane

Tool for timing belt tension



215 574 Renault Megane

### Chiave tensionamento cinghia Renault



215 575 Benzina - quadro mm 8x180

215 576 Diesel - quadro mm 9x200

### Piastrina ritegno tendicinghia motori VW AJM

Wrench for Block toothed timing belt VW AJM motor

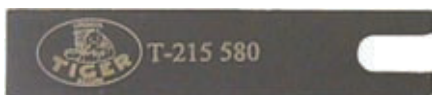

215 580

### Set chiavi smontaggio ventilatori VISCO

7 Pz Benz & Bmw fan service wrench kit



215 590 BMW - FORD - MERCEDES - OPEL

### Chiavi smontaggio elettroventole BMW e AUDI

Fun clutch tools



Acciaio - Brunito

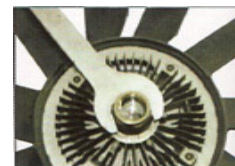

mm 400

215 590 32 mm 32

215 590 36 mm 36

### Attrezzo inserimento / rimozione cinghie elastiche

Belt tool kit for elastic -ribbed belts



215 605

in valigetta

**Dati tecnici - Informative**

- Motori con pulegge elastiche: Alfa Romeo - Bmw - Chrysler - Volvo - Fiat - Ford - Mercedes - PSA - Seat - Skoda - Smart - Vw-Audi - etc

### Chiave tendicinghia

Timing tools Renault

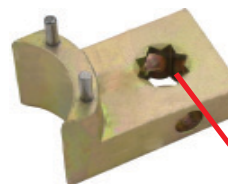

Attrezzo ideale per lavori in posti stretti e facile da utilizzare grazie all'attacco da 3/8" con doppio quadro

215 609

**Dati tecnici - Informative**

Lunghezza mm 47 - Profondità mm 32,5

**Attrezzo per rotazione tenditore cinghia distribuzione**

Devices for tension of timing belt



215 610 Nuova Punto Lancia Y - Mot.Eng.1200 cc 16v

**Attrezzo per tensionamento cinghia dentata comando distribuzione**

Devices for tension of toothed timing belt

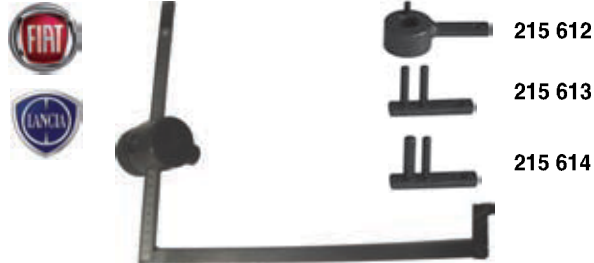

215 611 Uno 45-Fire-Tipo-Ritmo-Tempra-Regata-Croma - Thema ie/16 v Turbo-Punto -Alfa-155-164 Kit completo

**Ricambi - Spare parts**

- 215 611 Uno 45-Fire-Tipo-Ritmo-Tempra-Regata-Croma - Thema ie/16 v Turbo-Punto -Alfa-155-164
- 215 612 Staffa tonda / Round staff / Recambio redondo
- 215 613 Perno / Pin / Recambio - 6-6 mm
- 215 614 Perno / Pin / Recambio - 6-8 mm

**Attrezzo per tensionamento cinghia dentata comando distribuzione**

Devices for tension of toothed timing belt



215 616 Ritmo Diesel

**Attrezzo per tensionamento cinghia**

Devices for tension of toothed timing belt

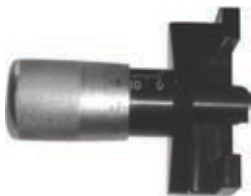

215 617

**Perno per tensionamento cinghia dentata comando distribuzione**

Devices for tension of toothed timing belt



215 618 Fiat Ulisse

**Attrezzo rotazione albero motore Mercedes A112 - A123**

Flywheel rotation tool Mercedes A112 - A123



215 619 L= mm 700

**Attrezzo fermo puleggia dentata organi ausiliari**

Devices for locking service belt



215 621 127-Uno 60/70/Turbo-Ritmo 60/es/70/85-Regata 60/ - S/70/85

**Attrezzo fermo puleggia dentata organi ausiliari**

Devices for locking service belt



215 622 127 1050-Rustica-Ritmo 60

**Attrezzo montaggio smontaggio tendicinghia**

Devices for dismounting timing belt turnbuckle



215 624 Bravo 1998 20v-Kappa Motor Vis

**Bussola femmina per vite puleggia albero motore Toyota 1ZZ-FE**

1/2" 10S size: 1/2"DR X 10S, HEX21mm

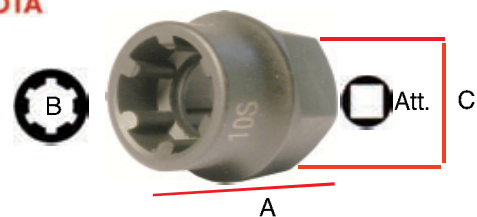

	A	B	C	Att.
215 625	32	10S	Esagono mm 21	1/2"



**Chiave tendicinghia Motori Audi**

Wrench for tension tothed belt



215 626 mm 46

**Bussola femmina per viti testate e vite centrale puleggia albero motore Nissan**

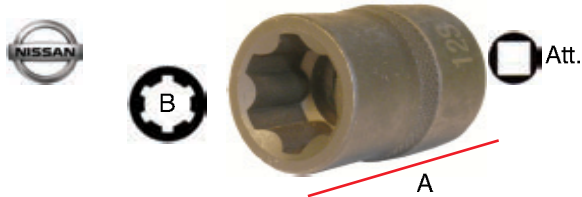

	A	B	Att.
215 627	38	12S	1/2"

**Chiave tendicinghia Motori Ford**

Wrench for tension tothed belt

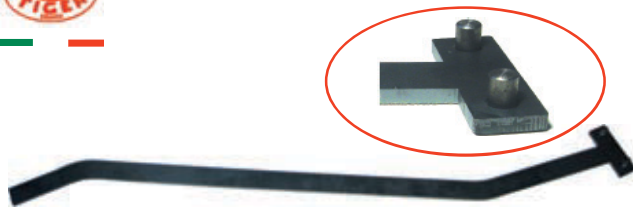

215 628 mm 840

**Chiave per pulegge e organi ausiliari**

Benz fan belt service wrench

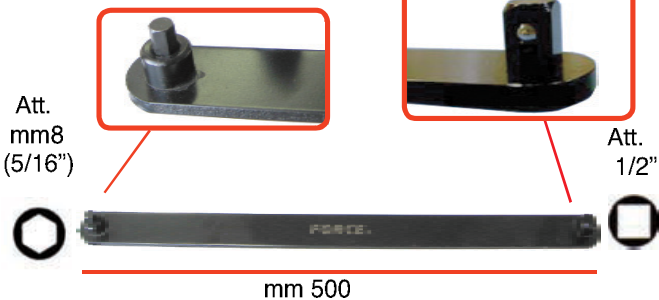

**Dati tecnici - Informative**

Strumento universale ideato per Mercedes e Nissan. L'attacco maschio quadro 1/2" da un lato, l'esagono porta inserti da 8mm (5/16") dall'altro, disegnati su di una barra stretta, lunga, piatta e molto resistente permette di lavorare in più zone con accesso confinato

**Chiave manovra semipuleggia tensionamento cinghia comando pompa acqua**

Wrench for water pump belt



215 630 Cromo D/TD

**Chiave manovra semipuleggia tensionamento cinghia comando compressore condizionamento**

Wrench for air conditioned compressor belt



215 631 Cromo D/TD

**Chiave tendicinghia**

Wrench for tension tothed belt



215 632 Golf 1600- Golf TD

215 632 01 Lunga per motori AJM-115-130-150 CV

**Set 5 Pz chiavi poligonali piatte, sottili, lunghe, per rotazione pulegge distribuzione, organi ausiliari e tendicinghia**

5 Pcs poligonal wrench set, long and flat, for pulley and tension tothed

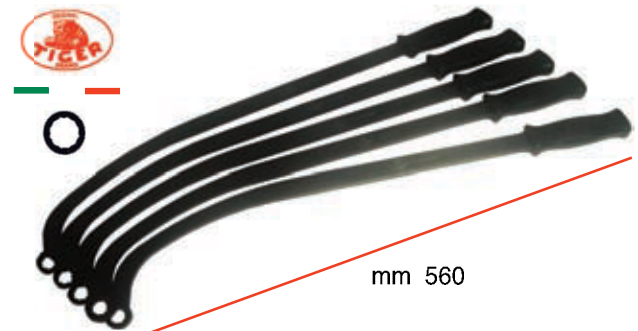

215 634 mm 13 - 15 - 16 - 17 - 19

215 634 12 Non inclusa nel set - mm 12

215 634 13 mm 13

215 634 14 Non inclusa nel set - mm 14

215 634 15 mm 15

215 634 16 mm 16

215 634 17 mm 17

215 634 18 Non inclusa nel set - mm 18

215 634 19 mm 19

**Attrezzo per posizionamento piastrina porta sensore**

Devices for little plate positioning side camshaft



215 635 Ritmo ES

**Calibro controllo posizionamento tendicinghia distribuzione**

Gauge control positioning of toothed timing belt turnbuckle



215 636 127 D

**Attrezzo ritegno supporto centrale per smontaggio albero distribuzione**

Tool retainment central engine support during replacement and installation of camshaft



215 637 127 D

**Chiave serraggio tendicinghia Motori Renault Benzina**

Wrench for tension toothed belt Renault engine gasoline



215 638

**Set chiavi poligonali piatte - sottili - con occhiello rinforzato, per pulegge distribuzione, organi ausiliari e tendicinghia**

5 pcs damper pulley luller set



215 639 mm 13 - 15 - 16 - 17 - 19 - Valigetta Pz 5  
mm 470



**Ricambi - Spare-parts**

- 215 639 13 Chiave singola mm13
- 215 639 15 Chiave singola mm15
- 215 639 16 Chiave singola mm16
- 215 639 17 Chiave singola mm17
- 215 639 19 Chiave singola mm19

**Set chiavi poligonali lunghe piatte con anello alto e sottile, ideale in officina per pulegge ed organi di servizio**

Extra long off set box poligonal wrench set

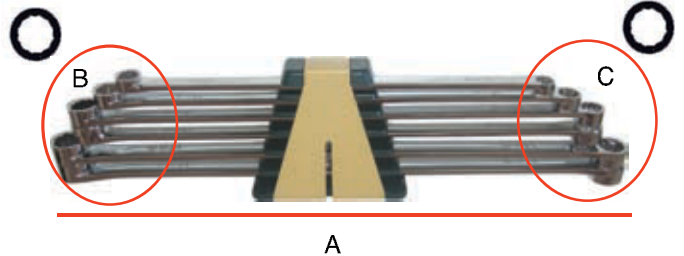

215 640 Kit 6 Pz

**Ricambi - Spare-parts**

	A	B	C
215 640 10	mm 290	mm 10	mm 12
215 640 12	mm 360	mm 12	mm 14
215 640 13	mm 360	mm 13	mm 15
215 640 14	mm 400	mm 14	mm 17
215 640 16	mm 400	mm 16	mm 18
215 640 17	mm 400	mm 17	mm 19

**Adattatori opzionali - Optional adaptor**

215 640 22 Non inclusa nel set mm 450 mm 22 mm 24

**Set chiavi Torx piatte, sottili, con occhiello rinforzato, per tendicinghia e organi ausiliari**

5 pcs damper pulley puller holder wrench set



215 641 E10 - E12 - E14 - E16 - E18

**Attrezzo universale per il montaggio e lo smontaggio delle cinghie elastiche**

Tacca sulla parte superiore per lo slittamento della cinghia

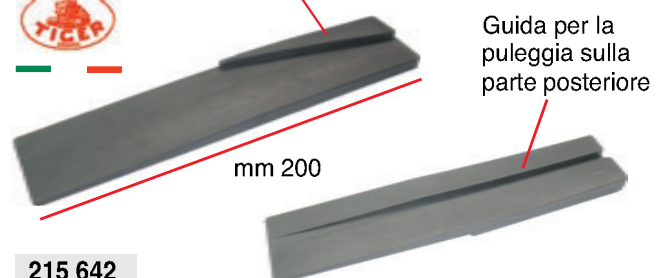

215 642

Vedi anche 215 605.

**Chiave di smontaggio per pulegge albero motore**

Reaction wrench for crankshaft pulley



215 643 In valigetta

**Dati tecnici - Informative**

- Per Vw Audi 4 & 5 cilindri con e senza l'ammortizzatore armonico
- Ideale per la sostituzione cinghia di distribuzione
- Utilizzabile anche da un singolo meccanico

**Chiave a battere da 1/2" per viti pulegge**

Hand impact wrench for pulley 1/2"



215 645

mm 570

**Estrattore puleggia trascinamento albero distribuzione**

Extractor for delivery driving pulley



215 650

Bravo-Brava-Punto-Tempra-145-146-Barchetta - Coupè-Lancia-Kappa-Ulisse

**Estrattore registrabile per puleggia trascinamento pompa iniezione**

Adjustable extractor for delivery driving pulley



215 651 2 zampe / 2 Legs / 2 patas - Ø 46-86 mm

**Ricambi - Spare parts**

215 653 zampa / Leg / pata

215 654 zampa / Leg / pata

**Estrattore registrabile per pulegge trascinamento pompe iniezione**

Adjustable extractor for delivery driving pulley



215 652 3 zampe / 3 Legs / 3 patas - Ø 46-86 mm

**Ricambi - Spare parts**

215 653 zampa / Leg / pata

215 654 zampa / Leg / pata

**Estrattore puleggia trascinamento albero distribuzione**

Extractor for delivery driving pulley



215 656 Peugeot-Passat

**Estrattore estensibile per pulegge Poly V**

Puller for ribbed pulleys

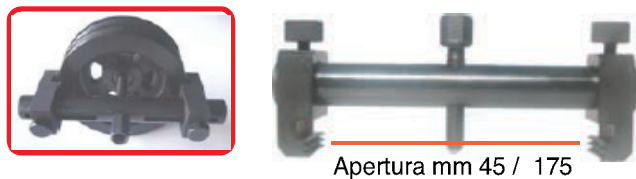

215 658

Apertura mm 45 / 175

**Estrattore puleggia trascinamento albero distribuzione**

Extractor for delivery driving pulley



215 660 Uno turbo D

**Estrattore pulegge con zampe orientabili**

Extractor pulleys with adjustable legs



215 664 FIAT - ALFA ROMEO - LANCIA





**Estrattore puleggia trascinamento albero distribuzione**

Extractor for delivery driving pulley



215 665 127 D

**Estrattore pompa iniezione per posizionamento ingranaggio**

Extractor for injection pump



215 671 Alfa 90 Bosch

**Estrattore girante pompa iniezione**

Extractor for turbine injection pump



215 673 Alfa 75-33 Bosch

**Estrattore puleggia trascinamento elettro ventilatore**

Extractor for fan coil driving pulley



215 675 Alfa 164 TD

**Attrezzo per posizionamento girante pompa acqua**

Devices for positioning water pump impel



215 677 Ritmo D

**Introduttore corteco albero distribuzione lato aspirazione**

Oli seal camshaft introducer



215 678 145-146-Spider Alfa-Bravo-Brava-Coupè

**Chiave per smontaggio alternatori**

Wrench for alternator disassembly



215 679 Alfa 159 - Fiat Nuova Croma

**Attrezzo per sostituine cinghie alternatore**

Devicev for alternator pulley dismounting



215 680 Golf / Passat G 60

**Chiave per lo smontaggio e montaggio alternatori**

Alternator wrench



mm 90

215 681 Fiat Bravo. Grande Punto

**Kit inserti per alternatore**

Alternator bits



mm 120

215 682 Pz 5

**Ricambi - Spare parts**

215 682 01	Inserto esagonale per alternatore	8 x 120
215 682 02	Inserto esagonale per alternatore	10 x 120
215 682 03	Inserto XZN per alternatore	M 8 x 120
215 682 04	Inserto XZN per alternatore	M 10 x 120
215 682 05	Inserto Torx per alternatore	T50 x 120
415 661 41	Innesto 14x18	mm 41

**Chiave per lo smontaggio puleggia alternatori**

Alternator wrench



mm 110

215 683 Tx 50 Classe - A

### Chiave per lo smontaggio alternatori Valeo

Alternator wrench



mm 110

215 684 Chiave XZN M10 con esagono

**Ricambi - Spare parts**

215 6840 1 Solo esagono mm 28

### Chiave per lo smontaggio alternatori Valeo

Alternator wrench - Valeo



mm 110

215 684 02 Renault

### Chiave smonta alternatori VAG - MB - Bmw

Alternator wrench



215 684 03 XZN M10

### Chiave multi denti per puleggia alternatore bosch

Tool for alternator pulley dismounting



215 685



mm 50

215 686



mm 30

215 685 Audi - Volkswagen

215 686 Fiat

### Chiave per lo smontaggio alternatori

Alternator wrench



mm 100

215 686 01

**Dati tecnici - Informative**

\*Nata per la Nuova Alfa Mito è indicata per tutti i motori Fiat - Alfa - Lancia, dal 2007 in poi.

**Ricambi - Spare parts**



215 686 11 Chiave alternatori  
Fiat - Alfa - Lancia dal 2007 in poi

### Chiave multidenti per puleggia Mito

Alternator wrench for Mito



215 686 12

### Kit per lo smontaggio della puleggia alternatori Bosch - Marelli



215 687 Pz 7

**Ricambi - Spare parts**

215 686 Chiave multidentata corta

215 689 Chiave a 4 denti per dado puleggia

411 756 Bussola porta inserti

215 682 01 Inserto esagonale per alternatore - 8 x 120

215 682 02 Inserto esagonale per alternatore - 10 x 120

215 682 03 Inserto XZN per alternatore - M 8 x 120

215 682 04 Inserto XZN per alternatore - M 10 x 120

### Kit per lo smontaggio della puleggia alternatori Bosch - Marelli



215 688 Pz 8

**Ricambi - Spare parts**

215 686 Chiave multidentata corta

215 689 Chiave a 4 denti per dado puleggia

234 134 Chiave a bussola foro passante mm 22

411 756 Bussola porta inserti

215 682 01 Inserto esagonale per alternatore - 8 x 120

215 682 02 Inserto esagonale per alternatore - 10 x 120

215 682 03 Inserto XZN per alternatore - M 8 x 120

215 682 04 Inserto XZN per alternatore - M 10 x 120

NOTE



---



---



---



---



---



---

**Kit per lo smontaggio della puleggia alternatori Bosch - Marelli**

Alternator wrench Bosch - Marelli



215 688 01 Pz 9

**Ricambi - Spare parts**

- 215 686 Chiave multidentata corta
- 215 689 Chiave a 4 denti per dado puleggia
- 234 134 Chiave a bussola foro passante mm 22
- 234 135 Chiave a bussola foro passante mm 24
- 411 756 Bussola porta inserti
- 215 682 01 Inserto esagonale per alternatore - 8 x 120
- 215 682 02 Inserto esagonale per alternatore - 10 x 120
- 215 682 03 Inserto XZN per alternatore - M 8 x 120
- 215 682 04 Inserto XZN per alternatore - M 10 x 120

**Kit per lo smontaggio della puleggia alternatori Bosch - Marelli - Valeo**



215 688 02 Pz 11

**Ricambi - Spare parts**

- 215 682 Kit 5 inserti
- 215 684 01 Solo esagono da mm 28 per puleggia
- 215 686 Chiave multidentata corta
- 215 689 Chiave a 4 denti per dado puleggia
- 234 134 Chiave a bussola foro passante mm 22
- 234 135 Chiave a bussola foro passante mm 24
- 411 756 Bussola porta inserti

**Kit per alternatori Bosch, Marelli e Valeo**



215 688 10 Kit in valigetta - 11 Pz

**Ricambi - Spare parts**

- |            |                                    |            |
|------------|------------------------------------|------------|
| 215 682 01 | Inserto esagonale per alternatore  | 8 x 120    |
| 215 682 02 | Inserto esagonale per alternatore  | 10 x 120   |
| 215 682 03 | Inserto XZN per alternatore        | M 8 x 120  |
| 215 682 04 | Inserto XZN per alternatore        | M 10 x 120 |
| 215 682 05 | Inserto Torx per alternatore       | T50 x 120  |
| 215 684 01 | Esagono mm 28                      | Valeo      |
| 215 686    | Chiave multi denti                 | Bosch      |
| 215 689    | Chiave a 4 denti                   | Marelli    |
| 234 134    | Chiave a bussola con foro passante | 22         |
| 234 135    | Chiave a bussola con foro passante | 24         |
| 411 756    | Bussola porta inserti esagonale    | 10x1/2"    |

**Kit per alternatori Bosch - Marelli - Valeo**

16 Pcs V-belt pulley remover bit socket set



215 688 16 16Pz

**Kit per alternatori Bosch - Marelli - Valeo**

18 Pcs V-belt pulley remover bit socket set



215 688 18 18Pz

**Kit per alternatori Bosch - Marelli - Valeo**

22 Pcs V-belt pulley remover bit socket set



215 688 22 22Pz

Novità: Nel set è inclusa la nuova chiave a 3 denti per alternatori Toyota - Mini + la nuova chiave a 33 denti per Citroen - Peugeot

**Kit smontaggio puleggia alternatori Bosch - Marelli - Valeo**

23 pcs V-belt pulley remover bit socket set



215 688 23 Pz 23

Nel set sono incluse le nuove chiavi per:  
 - Chiave per Opel Denso  
 - Chiave a 3 denti per Toyota e Mini  
 - Chiave a 33 denti per Citroen e Peugeot



**Chiave a 4 denti per dado puleggia alternatori Marelli**

Tool for alternator pulley dismounting - Marelli



215 689

**Leva tensionamento cinghia servizi quadro mm 7- 8**

Tool for service belt



215 690

Lancia Z Td - Ulisse TD-peugeot 806 Citroen Evasion -160 mm

**Adattatore per alternatori Opel / Denso**

Alternator wrench Opel / Denso

Esagono femmina mm 10



mm 71

Esagono maschio mm 10



215 691

**Chiave a 3 denti con esagono di manovra per lo smontaggio alternatori Nippodenso Toyota - Mini**

Alternator wrench Nippodenso - Toyota - Rover



215 692

**Chiave a 3 denti con manico di manovra per lo smontaggio alternatori Nippodenso Toyota - Mini**

Alternator wrench Nippodenso - Toyota - Rover

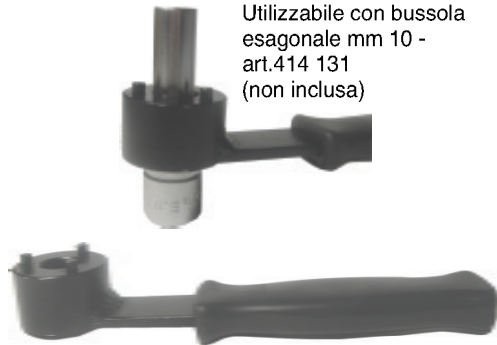

Utilizzabile con bussola esagonale mm 10 - art.414 131 (non inclusa)

mm 190

215 692 01 Chiave singola

**Chiave per lo smontaggio alternatori Opel - Denso**

Alternator wrench -



Att. 1/2"

215 693

**Pinza per acciaccatura cavi acceleratore**

Wire crimping plier



215 800

**Pinza fascette albero flessibile pieghevole con guaina**



215 808 In blister

**Pinza per fascette manicotti**

Plier for manifold band



215 810

**Ricambi - Spare parts**

215 810 01



215 810 02



**Pinza fascette manicotti bifilari piatte**

Spring clip pliers

Cromate - Isolate



mm 215



mm 280

215 810 10 mm 215

215 810 11 mm 280

**Pinza per fascette manicotti con albero flessibile**

Plier for manifold band with articulation cable

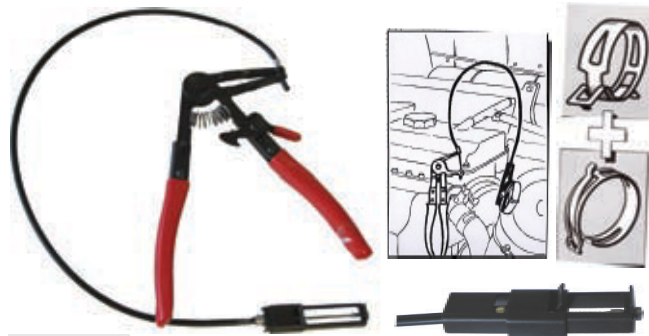

215 812

**Pinza per fascette manicotti con albero flessibile**

Plier for manifold band with articulation

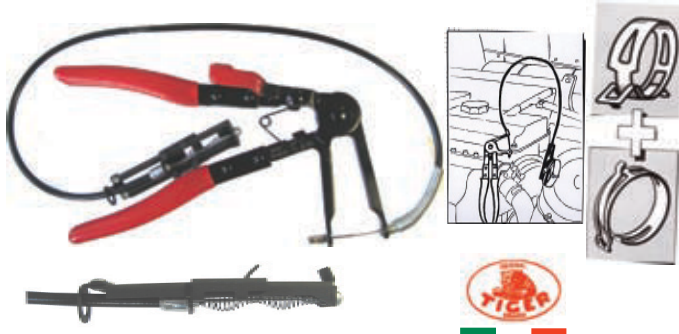

215 812 01

**Filo di ricambio per 215 812 e 215 812 01**

Spare steel cable for 215 812 & 215 812 01



215 812 02

**Pinza per fascette EGR con albero flessibile**

Plier for EGR band with articulation cable

Braccia corte per maggiore forza



215 812 03 In blister



**Cavo completo di pinza per ricambio**

Complete spare steel cable

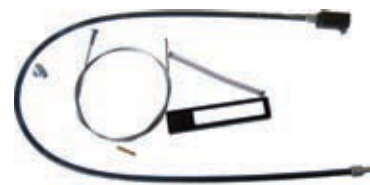

215 812 04 Ricambi per 215 812

215 812 05 Ricambi per 215 812 01

215 812 06 Ricambi per 215 812 03

**Pinza per fascette manicotti a filo tondo**

Plier for manifold band



215 813 mm 200

**Pinza per fascette manicotti con banda piatta larga**

Plier for manifold band



215 814 mm 200

**Pinza per fascette manicotti con banda piatta**

Plier for manifold band



215 815 mm 200

**Pinza per fascette manicotto a banda larga**

Plier for manifold band

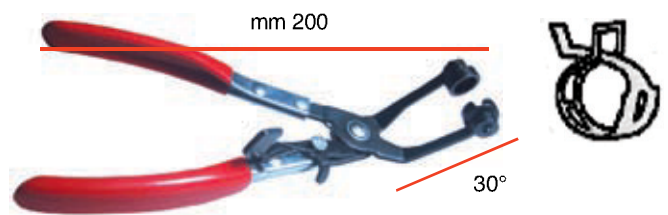

215 816 Piegata 30°

**Pinza per lo smontaggio fascette manicotti dei motori 2.0 TDi VW - Audi**

Plier for manifold band



mm 235



mm 300

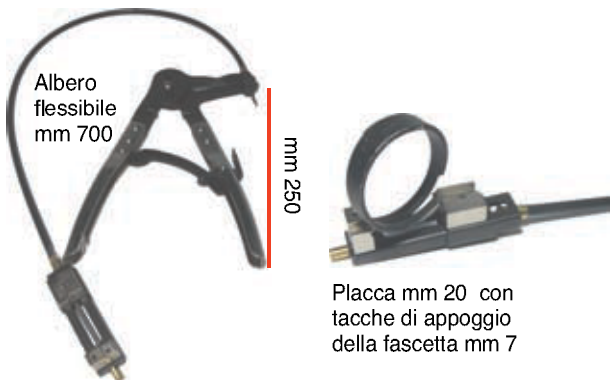

Albero flessibile mm 700

mm 250

Placca mm 20 con tacche di appoggio della fascetta mm 7

215 817 Pinza mm 235

215 818 Pinza mm 300

215 819 Con albero flessibile - Pinza mm 250

21581901 Filo di ricambio

**Pinza per fascette manicotti "Oeticher"**

Plier for oeticher band



215 820

**Pinza per fascette ad orecchio frontale**

Plier for front band

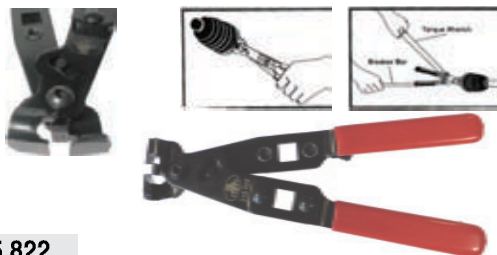

215 822

**Pinza per fascette manicotti extralunga**

Plier extralong for manifold band

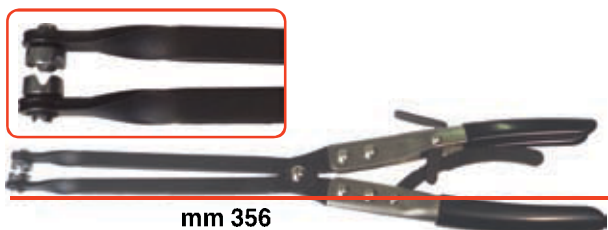

mm 356

215 823

**Pinza per fascette ad orecchio laterale**



215 823

**Pinza per fascette tubi carburante VAG**



215 830

Vw - Audi

195 mm

**NOTE**



---

---

---

---

---

---

---

---

---

---



www.afasupport.it